

DRAWN	REV.	DESCRIPTION	DATE	APPROVED
D. LAM	01	INITIAL RELEASE	11-02-10	
D. LAM	02	UPDATED PLATING SPECS.	9-30-11	
D. LAM	03	UPDATED Au PLATING FROM 3-5u" TO 4u" MIN.	11-11-11	

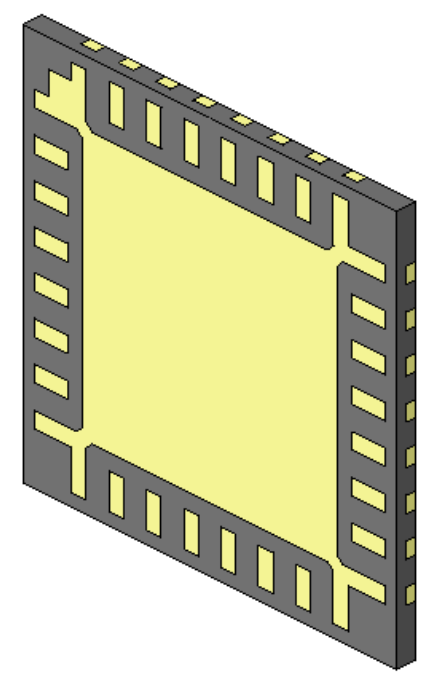

- NOTES: UNLESS OTHERWISE SPECIFIED,
1. APPLICABLE STANDARDS/SPECIFICATIONS:
ASME Y14.5M-1994, DIMENSIONING AND TOLERANCING
ASME Y14.38-1999, ABBREVIATIONS AND ACRONYMS.
 2. DIMENSIONS ARE SYMMETRICAL.
 3. L/F MATERIAL: CDA 194 F/H, 0.2540 ±0.0076 THK (.010" THK).
 4. PLATING: Ni/ Pd/ Au
 - * NICKEL PLATING - 80 μ" MIN UNDER
 - * PALLADIUM PLATING - 5-15 μ" UNDER
 - * GOLD PLATING - 4 μ" MIN
 5. BOTTOM CONTACT PADS ARE TO PROTRUDE OUTWARD FROM THE BODY BY 0.00 mm MIN TO 0.05 mm MAX.
 6. REMOVE ALL BURRS AND SHARP EDGES MAX ALLOWABLE BURR HEIGHT TO BE 0.0254 mm (.001").

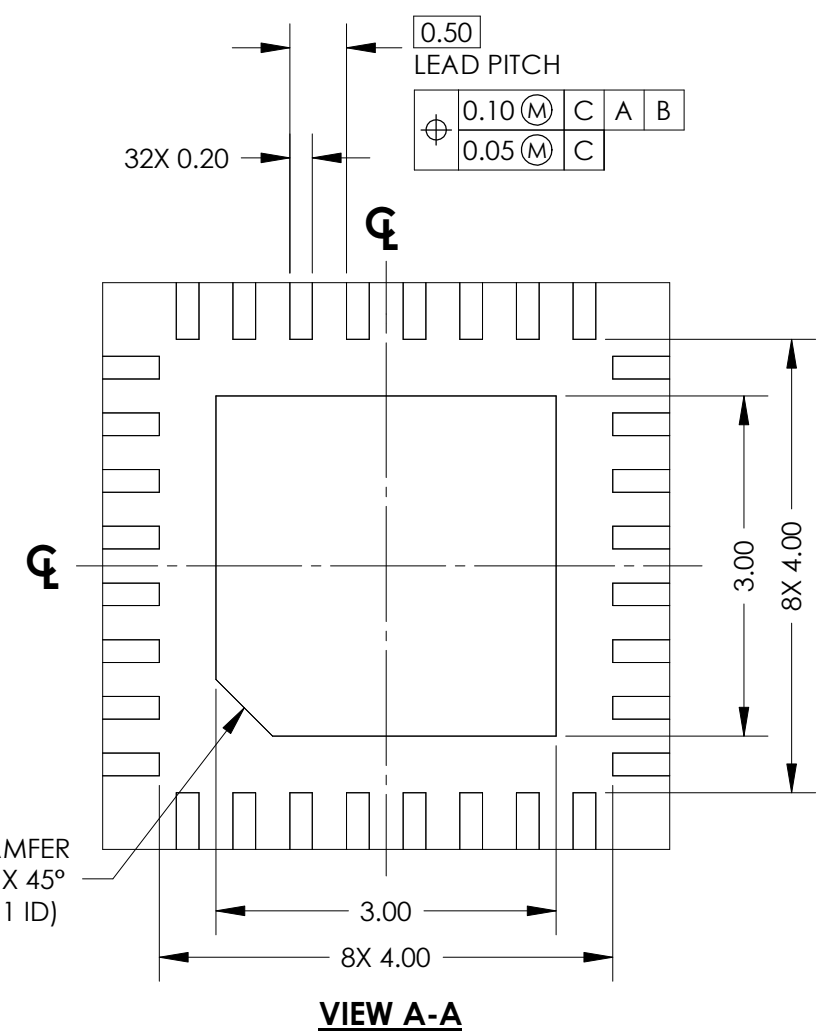
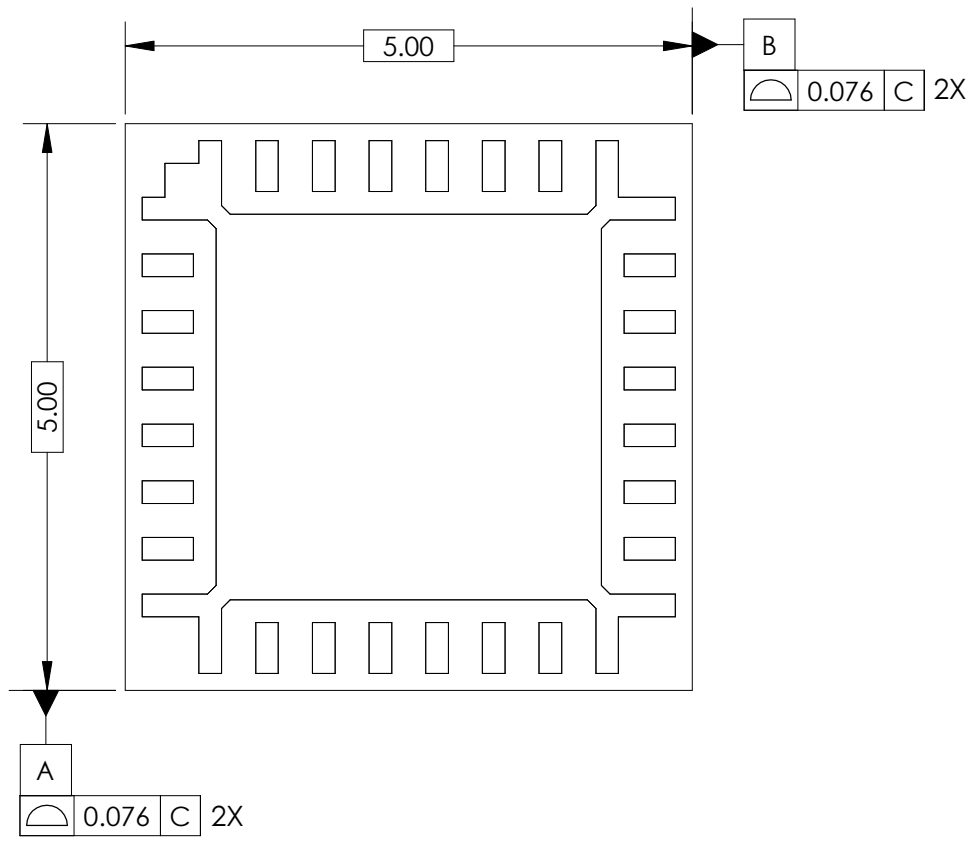
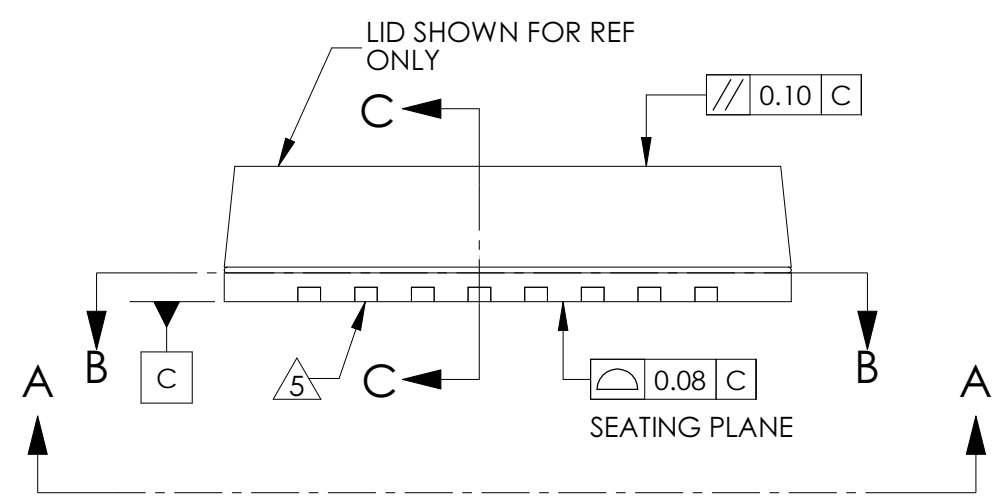

UNLESS OTHERWISE SPECIFIED:
ALL DIMS IN MILLIMETERS & INCLUDE CHEM. APPLIED/PLATED FINISH. REMOVE BURRS & SHARP EDGES. DO NOT SCALE.

TOLERANCES:
X = ±0.076
.XX = ±0.076
.XXX = ±0.076

ANGLES = ±1°

MATERIAL: SEE NOTES
FINISH: -

RJR POLYMERS, INC.

CAD FILE: RQFNA-01-00
CLIENT: -
DATE: 09-01-10
SCALE: NTS
SIZE: B
DRAWN: D. LAM
CHK'D: -
P/N: RQFNA-01-00
PAGE: 1 of 2
REV: 03

RQFN55-24-A, PACKAGE OUTLINE
5mm x 5mm QFN

CONFIDENTIAL

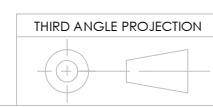

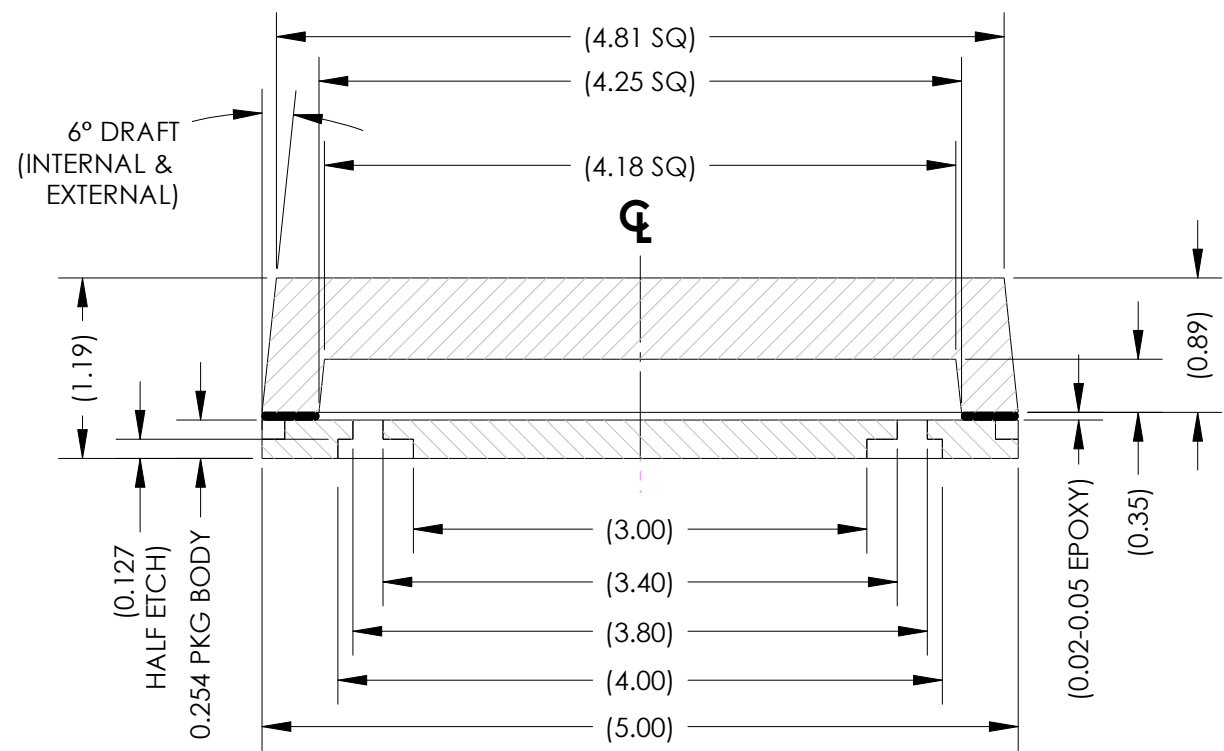
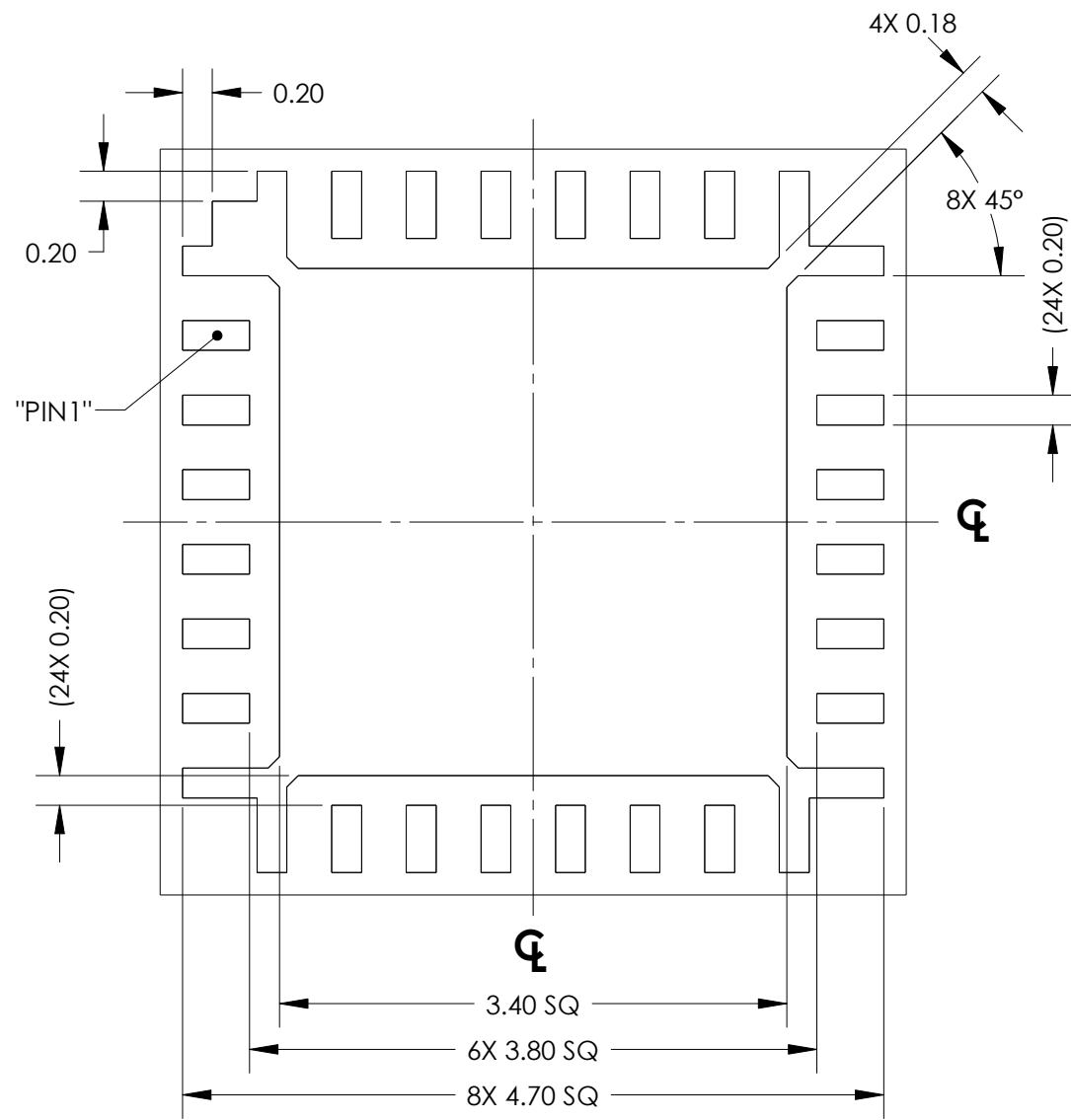

THIS DRAWING CONTAINS INFORMATION THAT IS CONFIDENTIAL AND PROPRIETARY PROPERTY OF R.J.R. POLYMERS, INC., AND ITS DESIGN, DETAIL AND INVENTION, ARE THE PROPERTY OF R.J.R. POLYMERS, INC., SUBMITTED TO THE RECIPIENT IN CONFIDENCE AND SHALL NOT BE COPIED IN ANY MANNER NOR DISCLOSED TO ANY OUTSIDE PARTY WITHOUT THE EXPRESS WRITTEN CONSENT OF AN AUTHORIZED OFFICER OF THIS COMPANY. THEY SHALL BE USED EXCLUSIVELY FOR REFERENCE WORK ON CONTRACTS OR PROPOSALS SUBMITTED BY R.J.R. POLYMERS, INC. AND SHALL BE RETURNED ON REQUEST. THIS DRAWING MUST BE KEPT ONLY IN THE CONFIDENTIAL FILES OF R.J.R. POLYMERS, INC., WHEN NOT IN USE. ALL RIGHTS RESERVED.

CAD FILE: RQFNA-01-00		RQFN55-24-A, PACKAGE OUTLINE			
CLIENT: -		5mm X 5mm QFN			
DATE: 09-01-10	SCALE: NTS	SIZE: B	DRAWN: D. LAM	CHK'D: -	P/N: RQFNA-01-00
					PAGE: 2 of 2
					REV: 03

CONFIDENTIAL