

THESE ITEMS CAN BE USED ON ANY MODEL ITS

ITS400

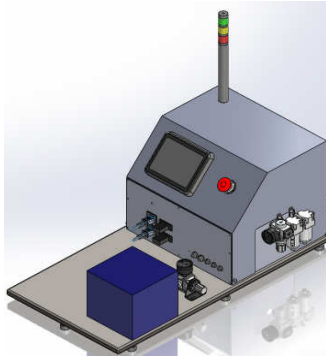

ITS500

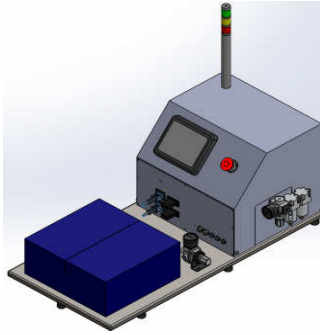

ITS600

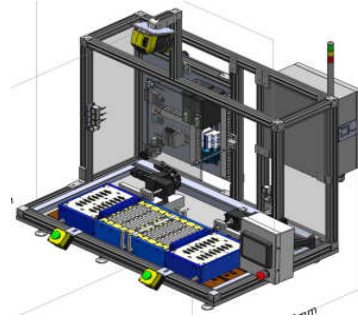

CLAM SHELL SIZES

ITS400

5X5

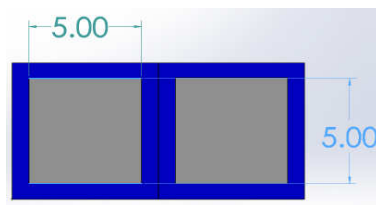

6X8

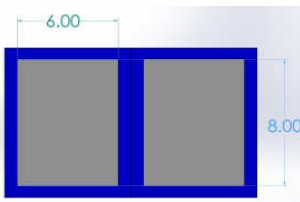





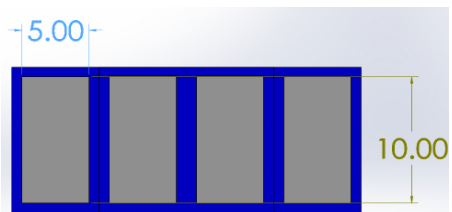



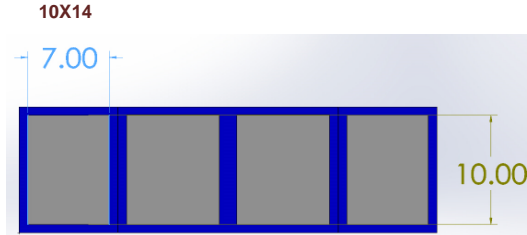







ITS500















10X10



ITS600



No.	Description	Photo	Part Number	MODEL	CATEGORY
1	VITON U-CAP RINGS		1700	ALL ITS MODEL	CLAMSHELL
2	PLUNGER SPRING		1701	ALL ITS MODEL	CLAMSHELL
3	PISTON		1427	ALL ITS MODEL	CLAMSHELL
20	CRIMP CONNECTOR (FEMALE)		4519	ALL ITS MODEL	CLAMSHELL
21	CRIMP CONNECTOR (MALE)		4519	ALL ITS MODEL	CLAMSHELL
24	ITS6 5/32" (4MM) TUBE "T" CONNECTOR FITTING		7828	ALL ITS MODEL	CLAMSHELL
25	1/4" HI-TEMP TEE FITTING		--	ALL ITS MODEL	CLAMSHELL
26	RING CRIMP CONNECTOR FOR GROUND		--	ALL ITS MODEL	CLAMSHELL
55	LOCK CYLINDER		1379	ALL ITS MODEL	CLAMSHELL
116	CRUSH WASHER FOR SEALING PLATE		--	ALL ITS MODEL	CLAMSHELL
121	FUSE 1 AMP (FOR ALARM)		4526	ALL ITS MODELS	ELECTRONICS
128	BUZZER		1415	ALL ITS MODEL	ELECTRONICS
131	CRIMPED SPADE CONNECTOR		4518	ALL ITS MODEL	ELECTRONICS
132	POWER SWITCH MUSHROOM PUSH PULL/ E-STOP		1440	ALL ITS MODEL	ELECTRONICS
139	IDEC POWER SUPPLY 24VDC / 0.75Amp		6723	ITS400 (Output = 24VDC / 0.75Amp)	ELECTRONICS
146	SOLID STATE RELAY		7172	ALL ITS MODEL	ELECTRONICS
197	ANTISEIZE LUBRICANT		3041	ALL ITS MODEL	MISCELLANEOUS
198	HEATSINK COMPOUND		4267	ALL ITS MODEL (MAX. TEMP. 392 degrees F)	MISCELLANEOUS
201	INSERT PLATE POLISHING STONE KIT		7823	ALL ITS MODEL	MISCELLANEOUS

	EXTERNAL SUCTION REPLACEMENT FILTER		6095	ALL ITS MODEL	PNEUMATIC
264	INLINE VACUUM FILTER		6094	ALL ITS MODEL	PNEUMATIC
265	ITS6 EXTERNAL VACUUM FILTER ELEMENT		7824	ALL ITS MODELS	PNEUMATIC
266	ITS6 INTERNAL METAL VACUUM FILTER 1/4" NPT		7825	ALL ITS MODELS	PNEUMATIC
267	INTERNAL SUCTION FILTER		4638	ALL ITS MODELS	PNEUMATIC
270	TEFLON TUBING 3/8"OD, 1/4" ID.		7264	ALL ITS MODEL	PNEUMATIC
271	TEFLON TUBING 1/4" OD, 1/8" ID		1370	ALL ITS MODEL	PNEUMATIC
272	TEFLON TUBING 5/32" OD, 3/32" ID		1378	ALL ITS MODEL	PNEUMATIC
273	Pressure Solenoid Valve CPE10-M1BH-3GL-M5		7260	ALL ITS MODEL	PNEUMATIC
280	PRESSURE VALVE SILENCER (USE WITH 7260)		7262	ALL ITS MODEL	PNEUMATIC
274	Vacuum Solenoid Valve, CPE18-M1H-3GLS-1/4		7267	ALL ITS MODEL	PNEUMATIC
290	VACUUM VALVE SILENCER (USE WITH 7267)		--	ALL ITS MODEL	PNEUMATIC
275	PNEUMATIC MANIFOLD		4461	ALL ITS MODEL	PNEUMATIC
279	MANIFOLD ADD-ON VALVE SMC PNEUMATIC P/N :		5752	ALL ITS MODEL	PNEUMATIC
314	AIR PRESSURE REGULATOR		--	ALL ITS MODELS	PNEUMATIC

THESE ITEMS ARE FOR ITS400

ITS400

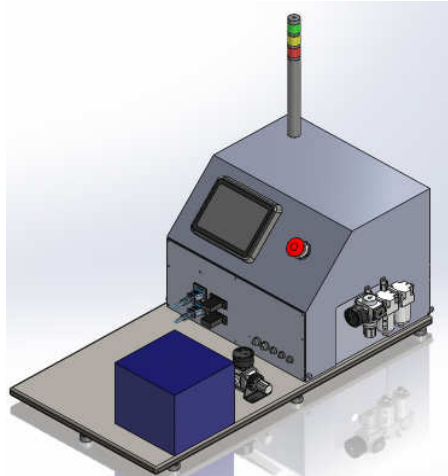

CLAM SHELL SIZES FOR ITS400



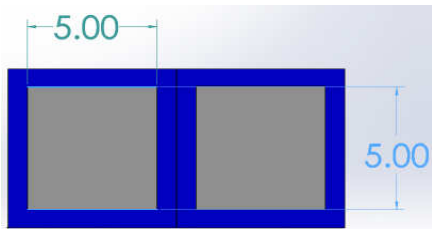



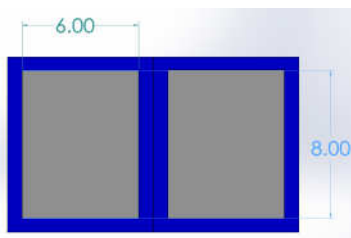







5X5



6X8



No.	Description	Photo	Part Number	MODEL	CATEGORY
5	O-RING, 70-SILICONE RUBBER .125"DIA.(1/8") FOR TOP HB COVER GASKET ITS 5x5		1702	ITS 400 (5 X 5) (3.734" INSIDE DIAMETER (W=0.139"))	CLAMSHELL
4	O-RING 70-SILICONE RUBBER .125"DIA. FOR TOP HEATER BLOCK ITS 6x8		3687	ITS400 (6.234" INSIDE DIAMETER (W=0.139"))	CLAMSHELL

11	TYPE J THERMOCOUPLE		1365	ITS400/500	CLAMSHELL
14	5X5 ITS UNIT= .25" DIA X 5" LONG (400W)		1366	ITS300 / ITS400	CLAMSHELL
15	6X8 ITS UNIT= .25" DIA X 8" LONG (800W)		2420	ITS400 ( 6 x 8)	CLAMSHELL
51	5/32" HOSE TO 10-32 MALE AIR PRESSURE FITTING, MATCH WITH PN 2176		4204	ITS400/500	CLAMSHELL
53	1/4" VACUUM FITTING 10-32 MALE		--	ITS400/500	CLAMSHELL
17	HIGH TEMP GASKET FOR HOSE FITTING		M-5GH	ITS400/500	CLAMSHELL
49	FITTING, PRESS., BRASS, 1/8-27 NPT X 10-32 FEMALE(AIR & PRESSURE FITTING), MATCH WITH PN 4204		2176	ITS400/500	CLAMSHELL
54	1/4NPT MALE X 10-32 FEMALE BRASS FITTING		--	ITS400/500	CLAMSHELL
52	ADJUSTABLE HINGE ASSEMBLY, ITS MODEL 400		4337	ITS400	CLAMSHELL
129	AC POWER ENTRY		1416	ITS400/500	ELECTRONICS
139	IDEC POWER SUPPLY 24VDC / 0.75Amp		6723	ITS400 (Output = 24VDC / 0.75Amp)	ELECTRONICS
146	SOLID STATE RELAY		7172	ITS400/500	ELECTRONICS
150	SAFETY RELAY (ITS500)		--	ITS400/500	ELECTRONICS
241	RUBBER FEET		1596	ITS400/500	PLATFORM
278	PISTON FLOW REGULATOR		--	ITS400/500	PNEUMATIC
314	AIR PRESSURE REGULATOR		--	ITS400/500	PNEUMATIC

THESE ITEMS CAN BE USED ON ANY MODEL ITS



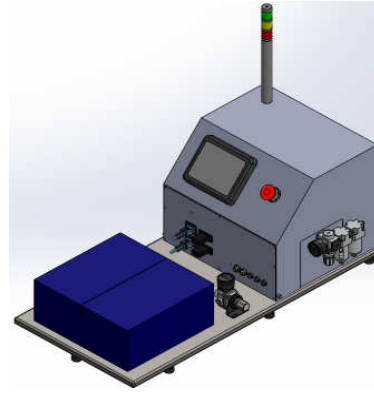



ITS500

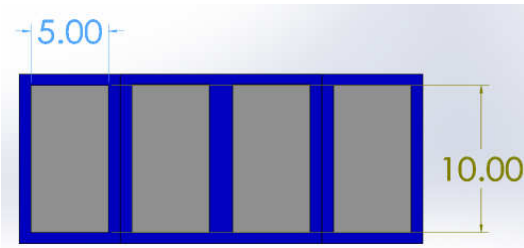













CLAM SHELL SIZES FOR ITS500

10X10



No.	Description	Photo	Part Number	MODEL	CATEGORY
1	VITON U-CAP RINGS		1700	ALL ITS MODEL	CLAMSHELL
2	PLUNGER SPRING		1701	ALL ITS MODEL	CLAMSHELL
3	PISTON		1427	ALL ITS MODEL	CLAMSHELL
6	O RING FOR TOP HEATER BLOCK ITS 10X10 (7.984" ID.,W=0.125")		5728	ITS600 (7.984" ID., (W=0.139"))	CLAMSHELL
7	O RING FOR TOP HEATER BLOCK ITS 10X10 (W=0.125")		6031		CLAMSHELL
8	O RING FOR TOP HEATER BLOCK ITS 10X10 (7.484" ID.,W=0.125")		7589	ITS 400 (6X 8) (6.734" ID., (W=0.139"))	CLAMSHELL
11	TYPE J THERMOCOUPLE		1365	ITS400/500	CLAMSHELL
12	TYPE J THERMOCOUPLE FOR ITS600		7131	ITS600/ITS500	CLAMSHELL

13	10x10 & 10x14 ITS Unit: .25" DIA X 10" LONG		5730	ITS600/ITS500	CLAMSHELL
51	5/32" HOSE TO 10-32 MALE AIR PRESSURE FITTING, MATCH WITH PN 2176		4204	ITS400/500	CLAMSHELL
53	1/4" VACUUM FITTING 10-32 MALE		--	ITS400/500	CLAMSHELL
54	1/4NPT MALE X 10-32 FEMALE BRASS FITTING		--	ITS400/500	CLAMSHELL
49	FITTING, PRESS., BRASS, 1/8-27 NPT X 10-32 (M5) FEMALE(AIR & PRESSURE FITTING), MATCH WITH PN 4204		2176	ITS400/500	CLAMSHELL
17	HIGH TEMP GASKET FOR HOSE FITTING		M-5GH	ITS400/500	CLAMSHELL
122	FUSE 1 AMP		6900	ITS600	ELECTRONICS
123	30A FUSE		6899	ITS600	ELECTRONICS
129	AC POWER ENTRY		1416	ITS400/500	ELECTRONICS
139	IDEC POWER SUPPLY 24VDC / 0.75Amp		6723	ITS400 (Output = 24VDC / 0.75Amp)	ELECTRONICS
150	SAFETY RELAY (ITS500)		--	ITS400/500	ELECTRONICS
241	RUBBER FEET		1596	ITS400/500	PLATFORM
278	PISTON FLOW REGULATOR		--	ITS400/500	PNEUMATIC
162	HINGES		6026	ITS500 / ITS600	PK

THESE ITEMS CAN BE USED ON ANY MODEL ITS

ITS600

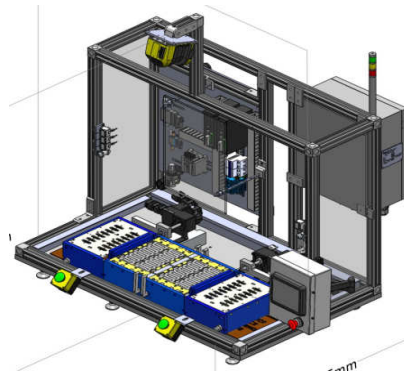





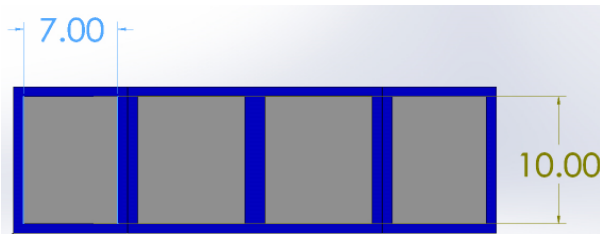





CLAM SHELL SIZES FOR ITS600

10X14



No.	Description	Photo	Part Number	MODEL	CATEGORY
9	O RING FOR BOTTOM HEATER BLOCK ITS 10X14 (7.737" ID., 7.943" OD, 450° F)		7758	ITS600 (7.737" INSIDE DIAMETER (W=0.139"))	CLAMSHELL
10	O RING FOR TOP HEATER BLOCK ITS 10X14 (7.484" ID., 7.762" OD, 450° F)		7759	ITS600 (7.734" INSIDE DIAMETER (W=0.139"))	CLAMSHELL
12	TYPE J THERMOCOUPLE FOR ITS600		7131	ITS600/ITS500	CLAMSHELL
13	10x10 & 10x14 ITS Unit: .25" DIA X 10" LONG		5730	ITS600/ITS500	CLAMSHELL
18	BRASS PRESSURE FITTING 5/32" (4MM) HOSE TO 1/4" NPT		7814	ALL ITS MODEL	CLAMSHELL
19	BRASS VACUUM FITTING 1/4" HOSE TO 1/8" NPT		7815	ALL ITS MODEL	CLAMSHELL
22	ITS6 STRAIGHT ADAPTER 3/8" TUBE-TO-MALE X 3/8" NPT FITTING		7826	ITS600	CLAMSHELL
23	ITS6 "T" ADAPTER 1/4" TUBE-TO-FEMALE X 3/8" NPT FITTING		7827	ITS600	CLAMSHELL



58	ITS6 BOT HB MID BAR INSULATOR		7821	ITS600	CLAMSHELL
116	CRUSH WASHER FOR SEALING PLATE		--	ALL ITS MODEL	CLAMSHELL
123	30A FUSE (MIAN DISCONNECT)		6899	ITS600	ELECTRONICS
126	SLOT SENSOR (5MM, NPN)		7257	ITS600	ELECTRONICS
127	PRESSURE SWITCH		7259	ITS600 (2 COLOR DISPLAY, HIGH PRECISION FOR POSITIVE PRESSURE (X2))	ELECTRONICS
147	POWER SUPPLY 24VDC / 1.75A		7358	ITS600	ELECTRONICS
196	TRACK ROLLER		--	TS600	MISCELLANEOUS
312	1/4" FLOW REGULATOR (GR-QB-1/4-U)		--	ITS600	PNEUMATIC
315	ACTUATOR POSITION SENSOR		--	ITS600	PNEUMATIC
162	HINGES		6026	ITS500 / ITS600	PK